

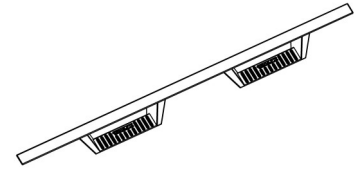

TrailFX Drop Down Step

Part No. DHS020B / DHS021B

Product image



Fits: Toyota Tundra Crew Max / Double Cab 2007-2019



TO AVOID BEING SCRATCHED, PLEASE PROTECT THE SURFACE OF THE TAILGATE VENT COVER CAREFULLY.



REMOVE CONTENTS FROM BOX. VERIFY ALL PARTS ARE PRESENT.



READ INSTRUCTIONS CAREFULLY BEFORE STARTING INSTALLATION.



ALIGN THE STEP BARS AS DESIRED AND TIGHTEN ALL M10 FASTENERS TO 30 ft. - lbs., AND THE M8 FASTENERS TO 15 ft.-lbs.



60 min



Cutting Not Required



Drilling Not Required



support@trailfx.com



1 866 638 4870



WARRANTY
POLISHED STAINLESS STEEL – LIMITED LIFETIME
POWDER COATED BLACK – 3 YEARS

PARTS LIST:

Item	Qty	Part Description	Tools Needed
1	1	Step Bar Driver Side	13 MM SOCKET & WRENCH
2	1	Step Bar Passenger Side	14 MM SOCKET & WRENCH
3	1	Front Mounting Bracket Driver Side	15 MM SOCKET & WRENCH
4	1	Front Mounting Bracket Passenger Side	RATCHET
5	1	Center Mounting Bracket Driver Side	TORQUE WRENCH
6	1	Center Mounting Bracket Passenger Side	
7	1	Rear Mounting Bracket Driver Side	
8	1	Rear Mounting Bracket Passenger Side	
9	12	M8 Bolt	
10	12	M8 Lock Washer	
11	12	M8 Flat Washer	
12	12	M10 Flange Bolt	
13	12	M10 Flange Nut	

Mounting Kit Images

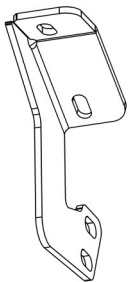

Item 3

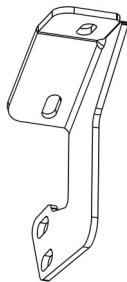

Item 4



Item 5



Item 6



Item 7

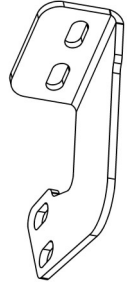

Item 8

INSTALLATION PROCEDURE

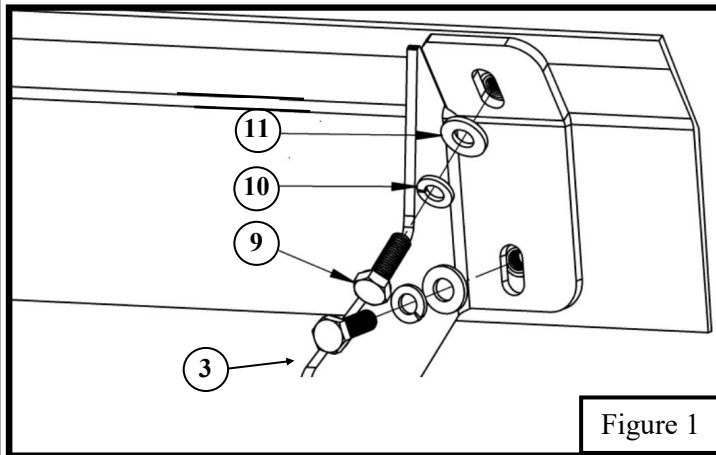
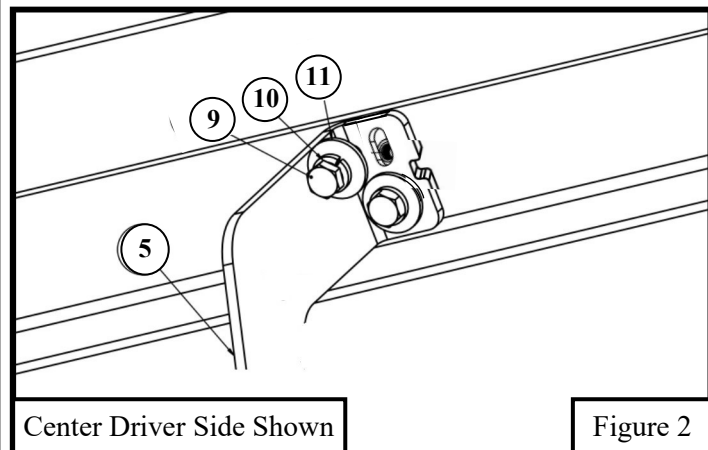

Figure 1

1. Start at the driver side of vehicle and grab Driver Side Mount Bracket. Use (2) M8 hex head bolts, (2) M8 flat washer, and (2) M8 lock washer to loosely mount bracket to rocker panel. See **Figure 1**.



Center Driver Side Shown

Figure 2

2. Move to the center driver side of vehicle and grab the Center Mount Bracket. Use (2) M8 hex head bolts, (2) M8 flat washer, and (2) M8 lock washer to loosely mount bracket to rocker panel. See **Figure 2** and See **Figure 3** for the Rear Mount Bracket.
3. Repeat for passenger side.

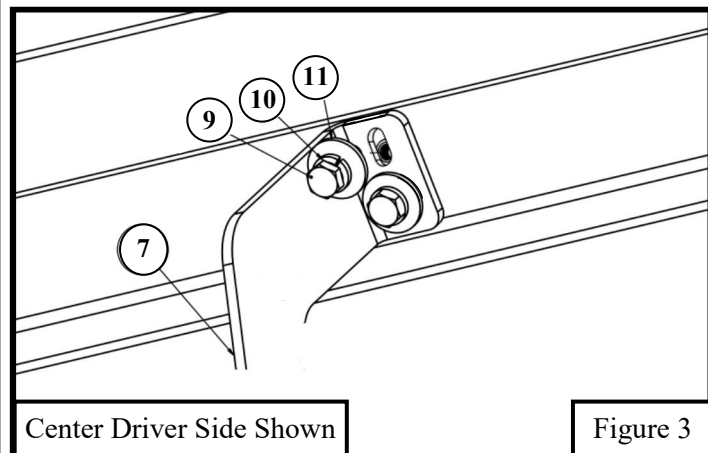

Center Driver Side Shown

Figure 3

4. Grab Driver Side Bar and install loosely to mount brackets with (6) M10 Flange bolts and (6) Serrated Flange Nuts. See **Figure 4**.
5. Repeat for Passenger Side.
6. Align and adjust the step bars as needed and tighten all hardware.
7. See **Figure 5** for reference.

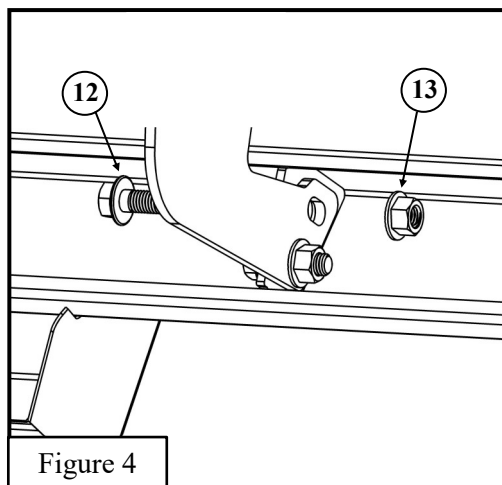

Figure 4

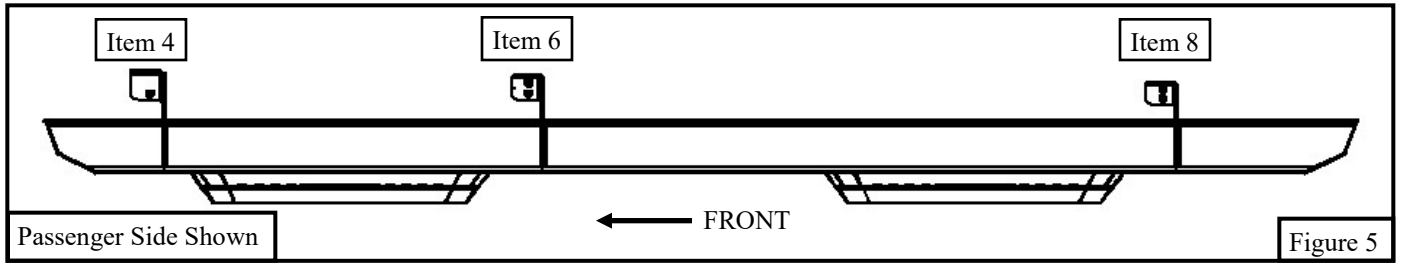

Figure 5



PRODUCT CARE

1. Periodically check the product to ensure all fasteners are tight and components are intact.
2. Mild soap may be used to clean the product.

FAQ's

1. **Mounting bracket are not getting Installed properly.**
In some cases Illustration images shown in Installation manual may not be the exactly same as per actual vehicle images ,also if Driver / Passenger side mounting brackets are very identical in the design, suggest referring Parts Identification guide to avoid fitment issue.
2. **Products are thumping / rattling after installation.**
Please ensure that all required mounting brackets / hardware's are installed & tighten correctly. Suggest using white lithium / regular grease between the metal to metal contact surfaces.
3. **Missing / Excess Hardware.**
Recheck hardware count as per the part list.
4. **Product not installing properly.**
Ensure make model year, cab length and bed size of your vehicle is listed in the application. All installation steps are followed correctly.

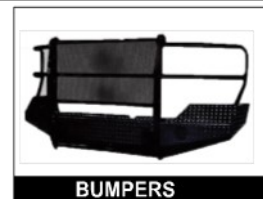
Check out these other TrailFX Products!!www.TrailFX.com**WINCHES****LED LIGHTS****HD GRILLE GUARDS****BUMPERS****TOOL BOXES**

Keystone Automotive Operations Inc. (KAO) warrants this product to be free of defects in material and workmanship at the time of purchase by the original retail consumer. KAO disclaims any other warranties, express or implied, including the warranty of fitness for a particular purpose or an intended use. If the product is found to be defective, KAO may replace or repair the product at our option, when the product is returned prepaid, with proof of purchase. Alteration to, improper installation, or misuse of this product voids the warranty. KAO's liability is limited to repair or replacement of products found to be defective, and specifically excludes liability for any incidental or consequential loss or damage.